

INSTALLATION

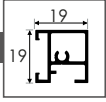

ALUMINUM CROSSBAR Profile 19×19 mm

pg2

Angle-bracket version with 2 dowels

pg3

Angle-bracket version with optional dowel

pg3

Sale Formats

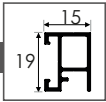

ALUMINUM CROSSBAR Profile 19×15 mm

pg4

Angle-bracket version with 2 dowels

pg5

Angle-bracket version without dowels

pg5

Sale Formats



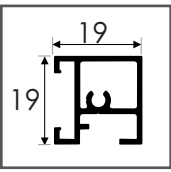

Aluminum Crossbar Profile 19×19 mm

ANGLE-BRACKET VERSION WITH 2 DOWELS

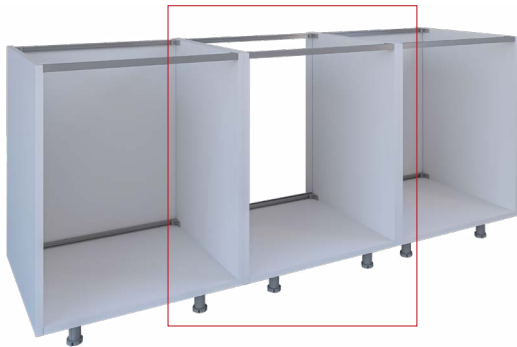

Front

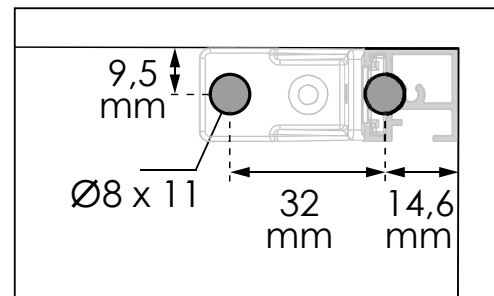
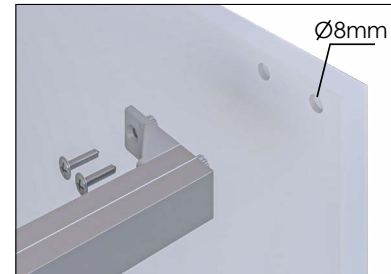
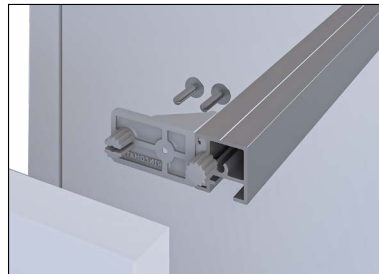

Upper / Lower Back Panel



! ready for 6mm (1/4") and 8mm (5/16") back panels

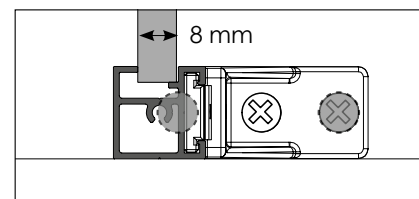
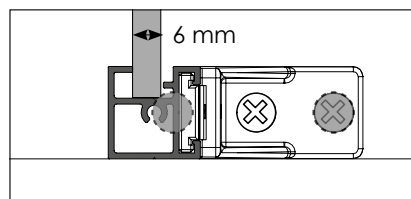
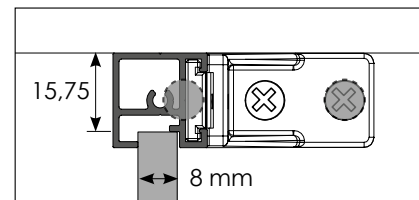
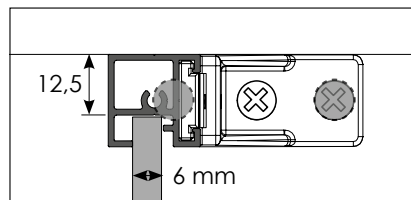

! flip crossbar to clamp 6mm (1/4") and 8mm (5/16") back panels

ANGLE-BRACKET VERSION WITH OPTIONAL DOWEL



BRACKET SET X2
DOWELS X2

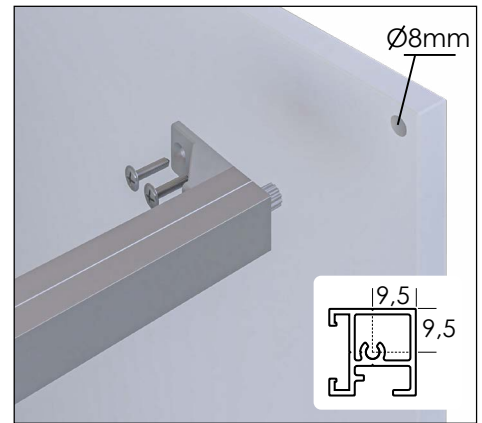
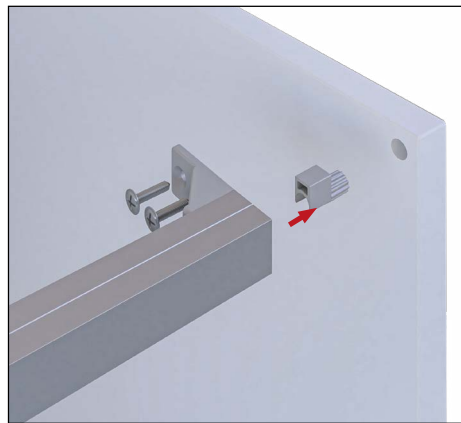

optionally machine the panel to use the included dowels

SALE FORMATS

custom length

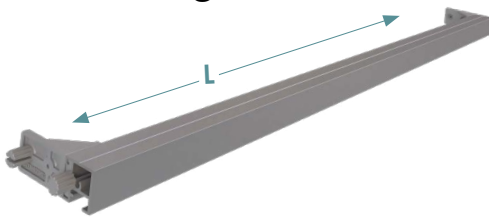

with brackets and dowels

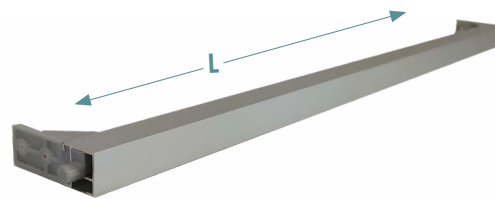

with brackets and optional dowel

by components

PROFILES

L1 / L2

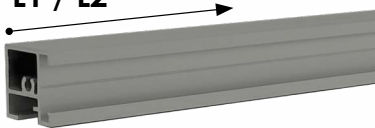

L1 = 2950 mm (116 in)

L2 = 2670 mm (105 in)

BRACKET SET X2 WITH
INTEGRATED DOWELS

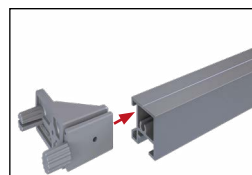

BRACKET SET X2 +
DOWELS X2



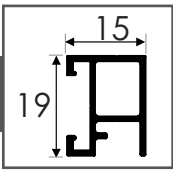

Aluminum Crossbar Profile 19×15 mm

ANGLE-BRACKET VERSION WITH 2 DOWELS

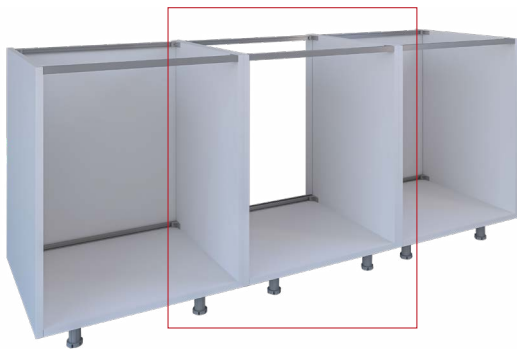

Front

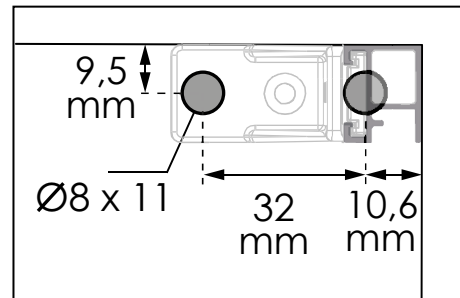
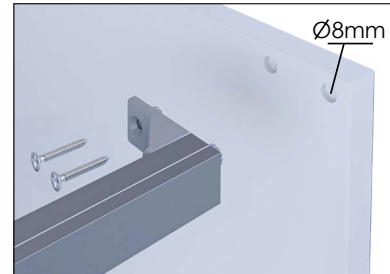
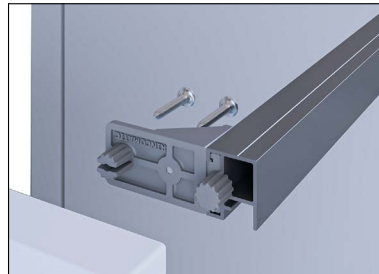

Upper / Lower Back Panel

! ready for 6mm (1/4") and 8mm (5/16") back panels

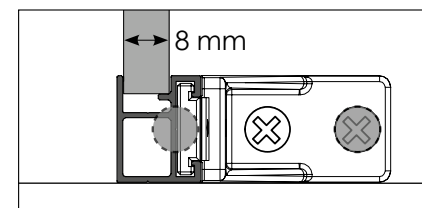
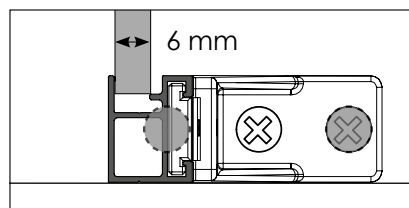
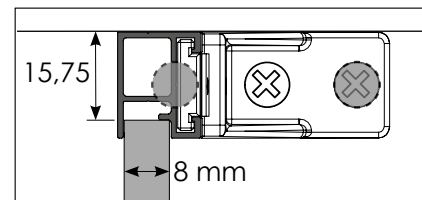
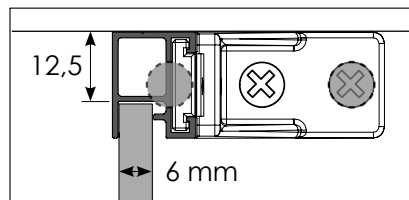

! flip crossbar to clamp 6mm (1/4") and 8mm (5/16") back panels

ANGLE-BRACKET VERSION WITHOUT DOWELS



BRACKET SET X2

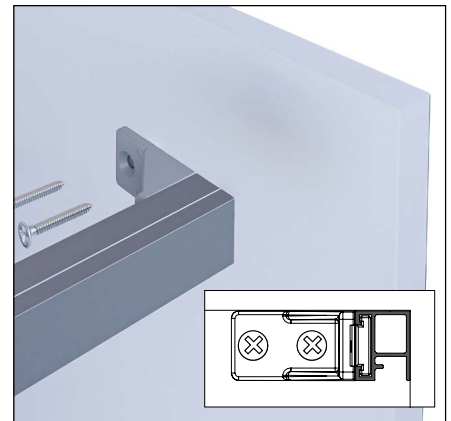
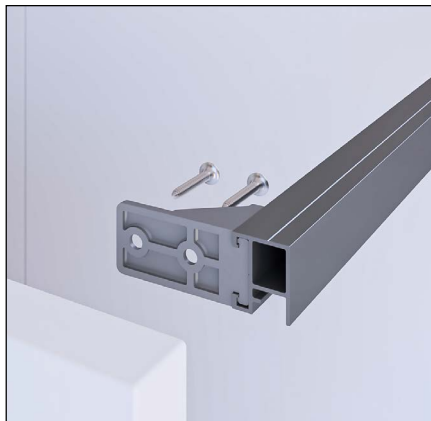

SALE FORMATS

custom length

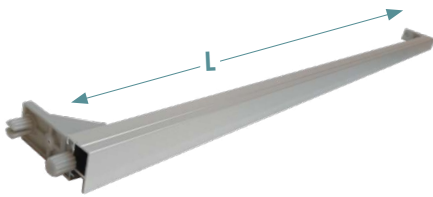

with brackets and dowels

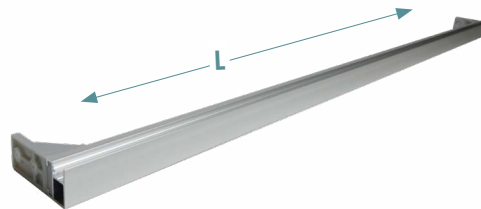

with brackets without dowels

by components

PROFILES

L1 / L2

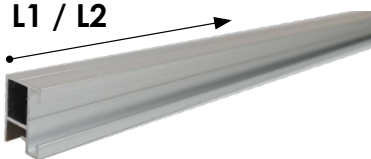

L1 = 2950 mm (116 in)

L2 = 2670 mm (105 in)

BRACKET SET X2 WITH INTEGRATED DOWELS



BRACKET SET X2

